



Features

- Shielded construction
- Inductance range: 1.0 to 100 μ H
- Heating current up to 5 A
- Dimensions: 6.7 x 6.7 x 4 mm
- AEC-Q200 qualified
- RoHS compliant* and halogen free**

Applications

- Automotive systems:
 - Driver assistant
 - Entertainment
 - Information
 - Lighting
- DC/DC converters
- Power supplies

SRR6040A Series - Shielded Power Inductors

Electrical Specifications @ 25 °C

Bourns Part Number	Inductance @ 10 kHz / 1 V		DCR (Ω) Typ.	DCR (Ω) Max.	I rms (A)	I sat (A)
	L (μ H)	Tol. (%)				
SRR6040A-1R0Y	1.0	± 30	0.0098	0.015	5.0	5.55
SRR6040A-3R0Y	3.0	± 30	0.0153	0.021	3.5	3.33
SRR6040A-5R0Y	5.0	± 30	0.0184	0.025	2.9	2.63
SRR6040A-6R8Y	6.8	± 30	0.0223	0.03	2.5	2.17
SRR6040A-8R2Y	8.2	± 30	0.0266	0.036	2.3	2.0
SRR6040A-100M	10	± 20	0.0358	0.05	2.0	1.72
SRR6040A-120M	12	± 20	0.0397	0.055	1.7	1.61
SRR6040A-150M	15	± 20	0.0428	0.06	1.6	1.51
SRR6040A-180M	18	± 20	0.0551	0.075	1.5	1.35
SRR6040A-220M	22	± 20	0.0647	0.087	1.3	1.22
SRR6040A-270M	27	± 20	0.0769	0.105	1.2	1.11
SRR6040A-330M	33	± 20	0.0903	0.12	1.1	1.02
SRR6040A-390M	39	± 20	0.103	0.135	1.0	0.94
SRR6040A-470M	47	± 20	0.123	0.16	0.95	0.85
SRR6040A-560M	56	± 20	0.149	0.19	0.86	0.77
SRR6040A-680M	68	± 20	0.187	0.24	0.75	0.7
SRR6040A-820M	82	± 20	0.22	0.29	0.7	0.63
SRR6040A-101M	100	± 20	0.266	0.345	0.65	0.57

How to Order

SRR6040A - 100M

Model _____
Value Code (see table) _____

Electrical Schematic

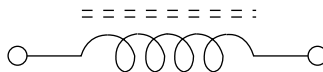

General Specifications

Operating Temperature -40 °C to +125 °C
(Temperature rise included)
Storage Temperature -40 °C to +125 °C
Resistance to Solder Heat +250°C for 10 sec.
Temperature Rise 30 °C typ. at rated I rms
Inductance drop 35 % at I sat

Materials

Core Ferrite
Wire Enameled copper
Terminal Finish Sn
Packaging 1000 pcs. per reel

Product Dimensions

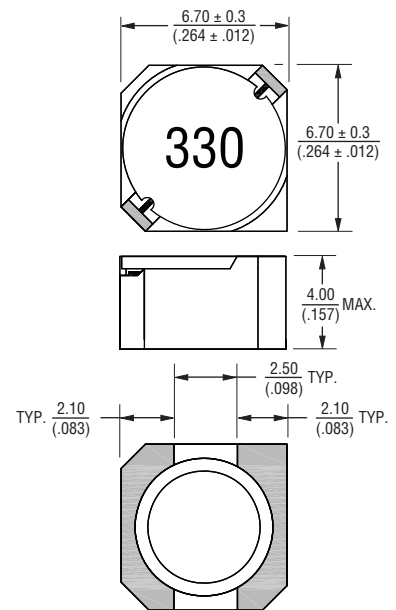

Recommended Layout

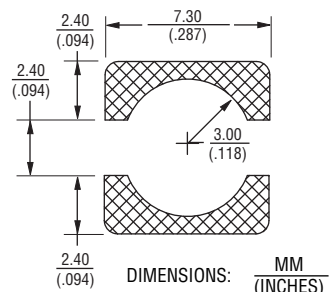

BOURNS®

Asia-Pacific: Tel: +886-2 2562-4117 • Fax: +886-2 2562-4116

EMEA: Tel: +36 88 520 390 • Fax: +36 88 520 211

The Americas: Tel: +1-951 781-5500 • Fax: +1-951 781-5700

www.bourns.com

* RoHS Directive 2002/95/EC Jan. 27, 2003 including annex and RoHS Recast 2011/65/EU June 8, 2011.
** Bourns follows the prevailing definition of "halogen free" in the industry. Bourns considers a product to be "halogen free" if (a) the Bromine (Br) content is 900 ppm or less; (b) the Chlorine (Cl) content is 900 ppm or less; and (c) the total Bromine (Br) and Chlorine (Cl) content is 1500 ppm or less.
Specifications are subject to change without notice.
The device characteristics and parameters in this data sheet can and do vary in different applications and actual device performance may vary over time.
Users should verify actual device performance in their specific applications.

SRR6040A Series - Shielded Power Inductors

BOURNS®

Inductance vs. IDC

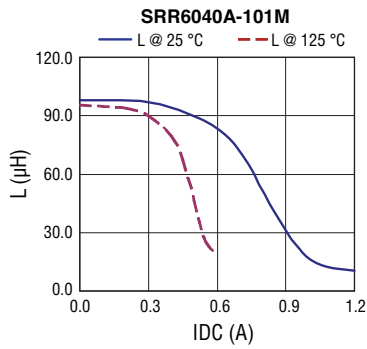
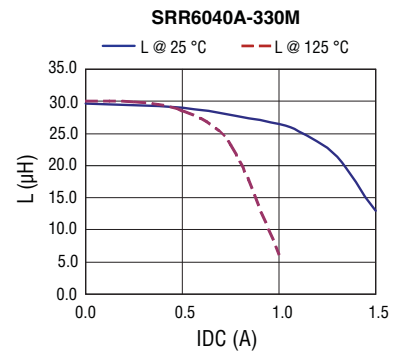
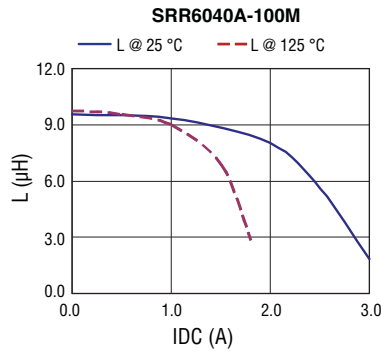
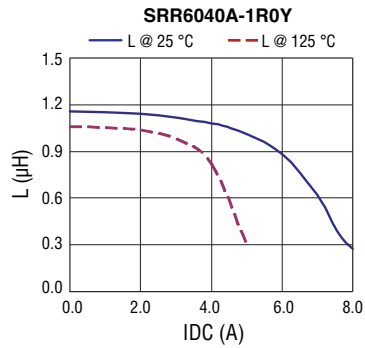

Temperature Rise vs. IDC

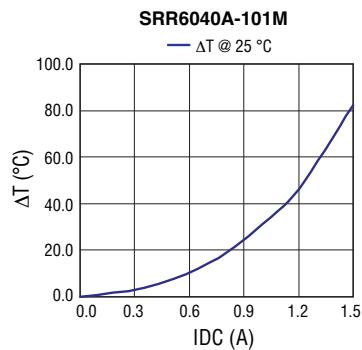
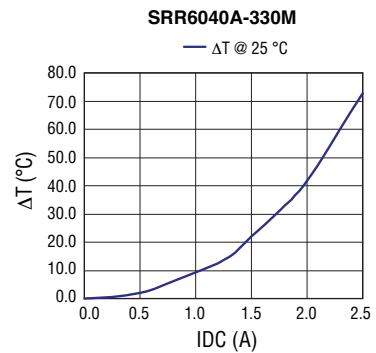
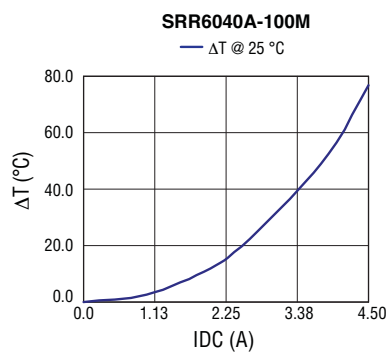
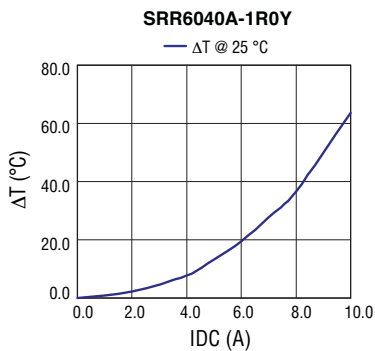

Specifications are subject to change without notice. The device characteristics and parameters in this data sheet can and do vary in different applications and actual device performance may vary over time. Users should verify actual device performance in their specific applications.

SRR6040A Series - Shielded Power Inductors

BOURNS®

Soldering Profile

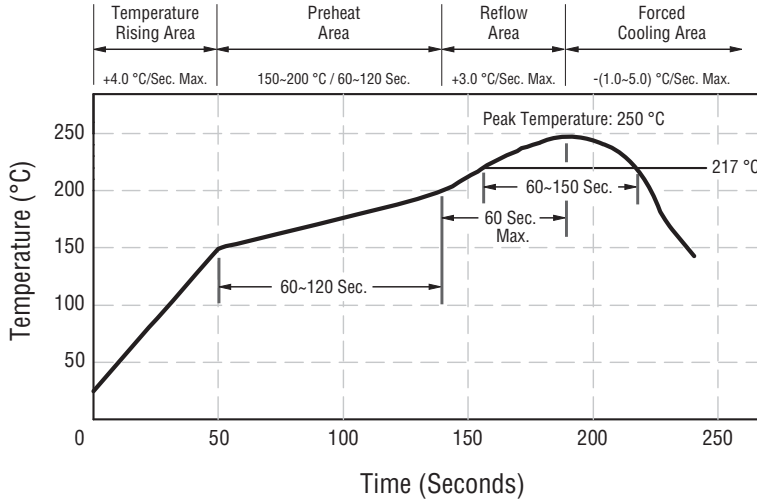

Peak Temperature: 250 °C max.
 Max. Peak Temperature -5 °C: 30 sec. max.
 Max. Time Above 217 °C: 60-150 sec. max.

Packaging Specifications

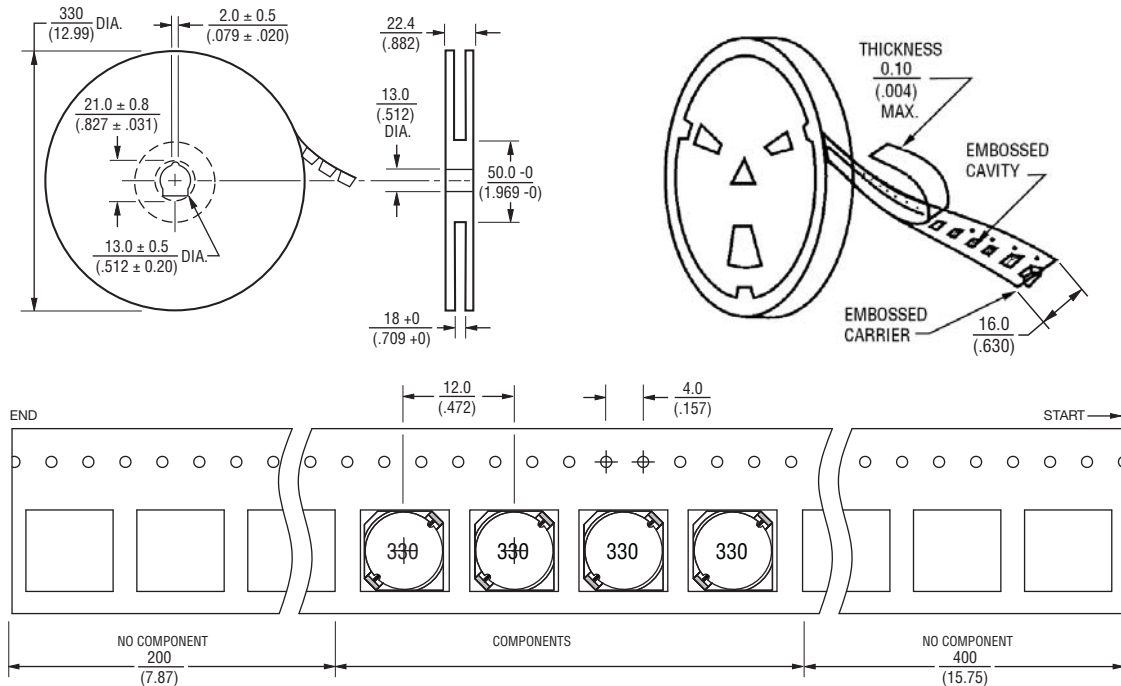

USER DIRECTION OF FEED →

QTY: 250 PCS. PER REEL

DIMENSIONS: $\frac{\text{MM}}{\text{(INCHES)}}$